

Appendix D

Maps, figures and illustrations

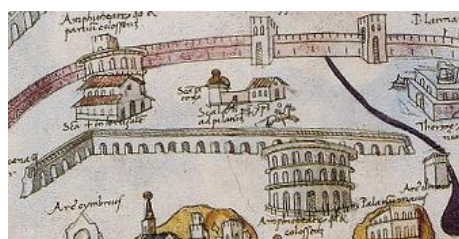

Figure D.1: 1472 Map of Rome (<http://roma.andreapollett.com>)



Figure D.2: Aqua Claudia (<http://www.maquettes-historiques.net>)

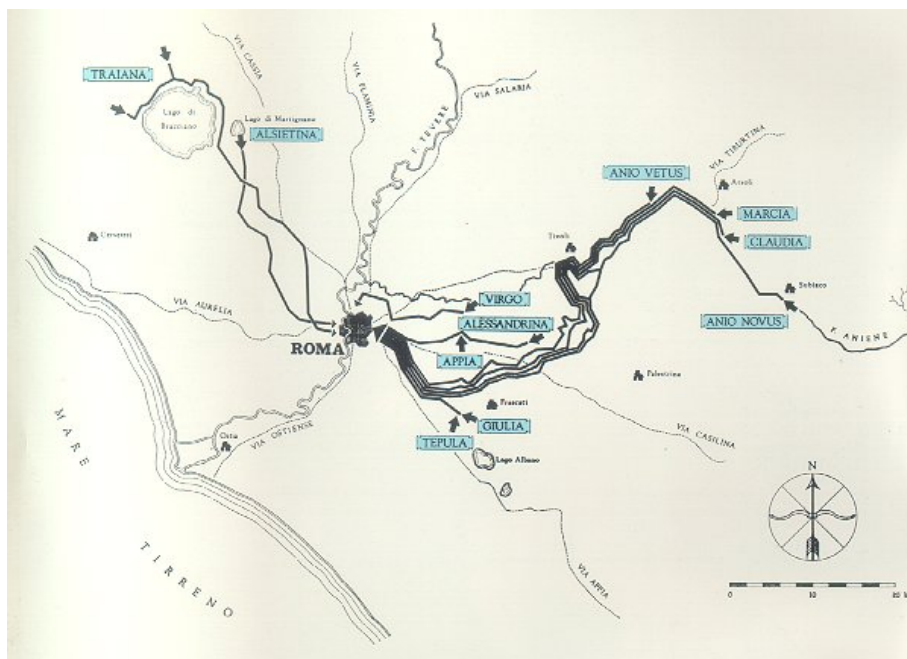

Figure D.3: Rome's aqueducts (<http://www.speakeasy.org/-bwduncan/aquae.html>)



Figure D.4: Rome (<http://www.the-colosseum.net/>)

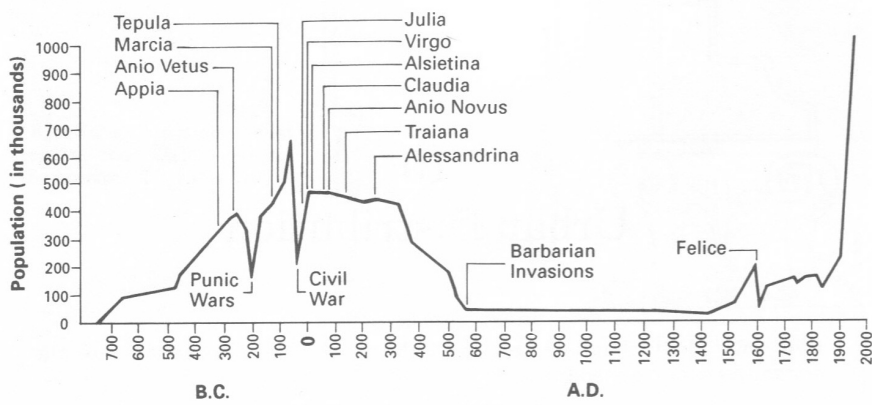

Figure D.5: Water Supply and Population (Hodge, 2002)



Figure D.6: Marcia Denarius - reverse (<http://www.romanaqueducts.info>)



Figure D.7: Marcia Denarius - obverse (<http://www.romanaqueducts.info>)



Figure D.8: Denarius "Gens" Marcia (<http://www.coinarchives.com/>)



Figure D.9: Traiani Sestertius (<http://www.coinarchives.com/>)



Figure D.10: The seven hills of Rome (Google Earth)



Figure D.11: Environs of Rome (Google Earth)



Figure D.12: Porta Maggiore (Google Earth)

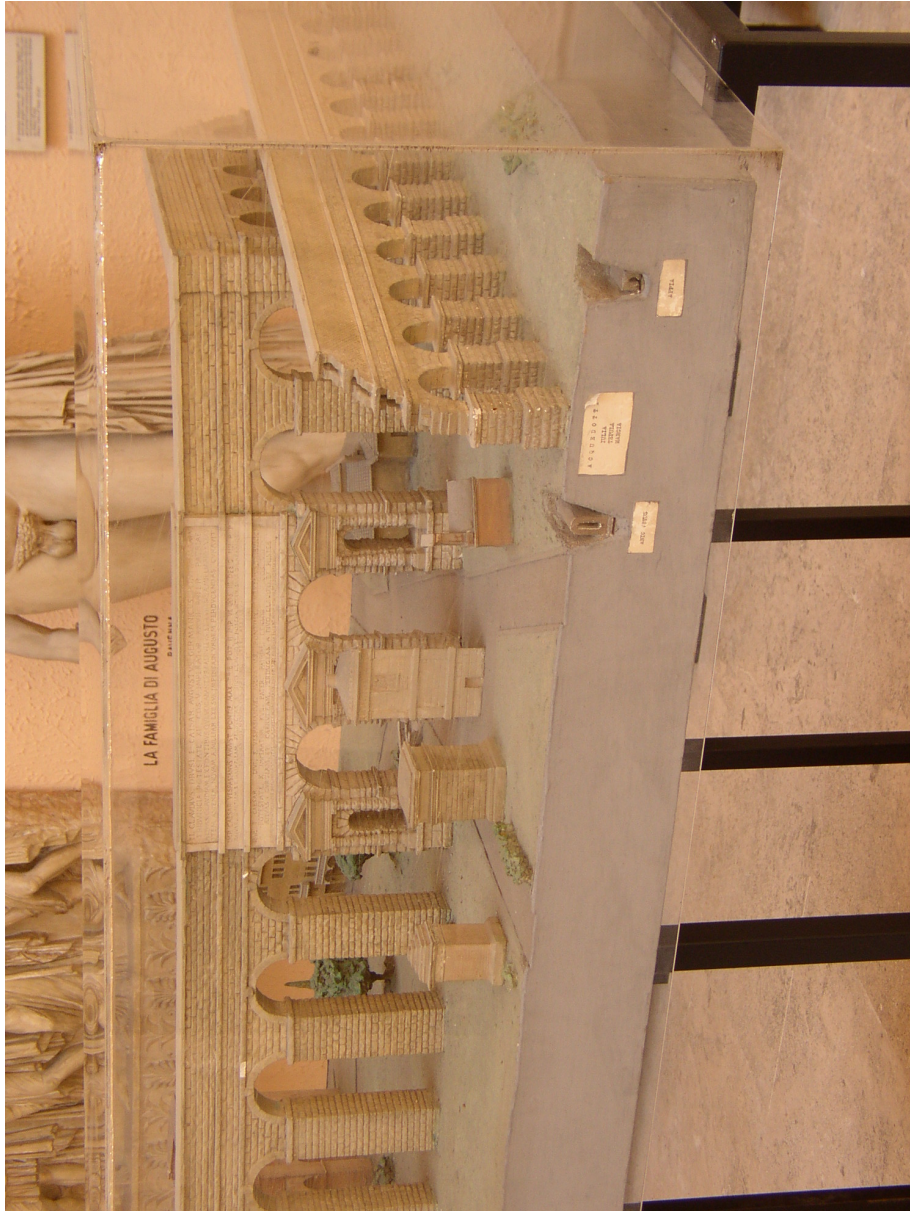

Figure D.13: Aqueduct model (<http://www.romanaqueducts.info>)

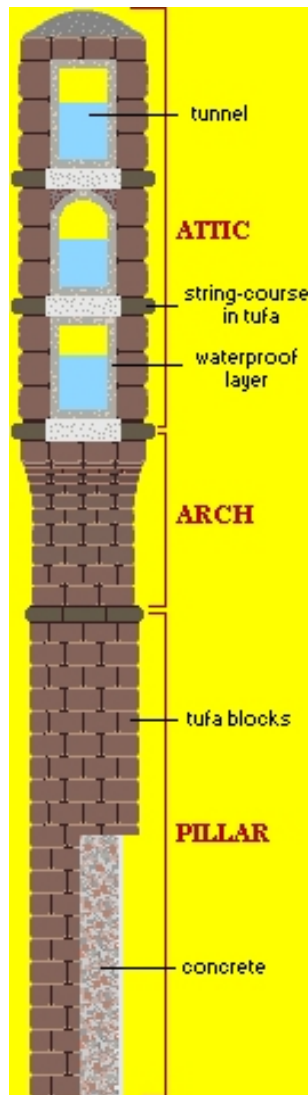

Figure D.14: Crosssection of a typical Roman aqueduct (<http://roma.andreapollett.com>)



Figure D.15: Chorabates: A - sights, B - weighted strings and notches and C - central channel. (<http://roma.andreapollett.com>)

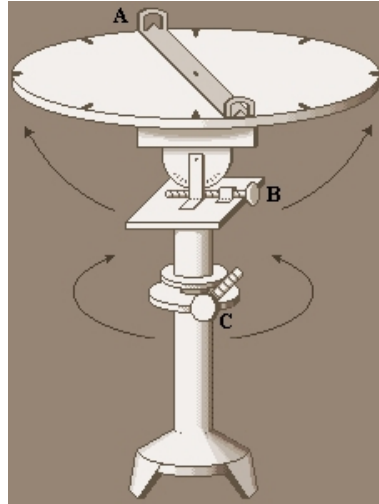

Figure D.16: Dioptra: A - sights, B - screw for adjusting the angle and C - screw for adjusting the direction. (<http://roma.andrea pollett.com>)



Figure D.17: Groma (<http://www.romanaqueducts.info>)



Figure D.18: Tomb of Lucius Aebutius Faustus (<http://corinth.sas.upenn.edu/gromatxt.html>)

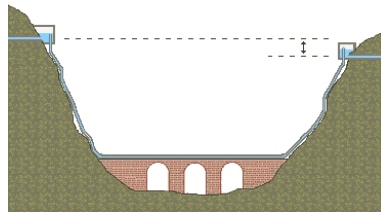

Figure D.19: Siphon (<http://roma.andreapollett.com>)



Figure D.20: Clay pipes in the Claudia (<http://www.romanaqueducts.info>)

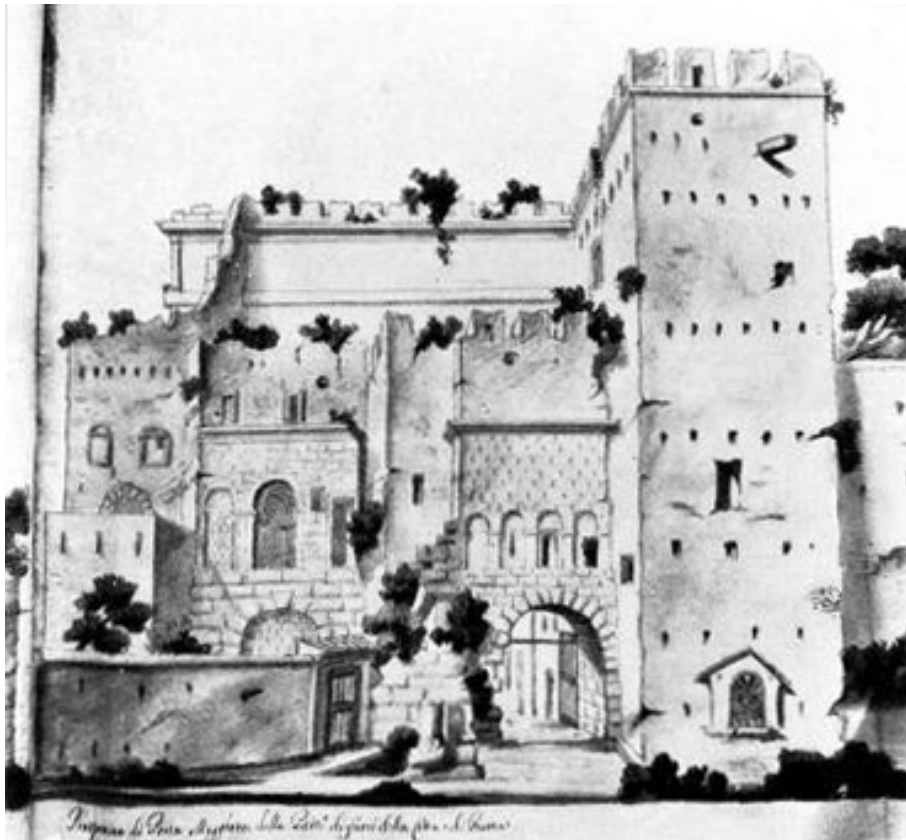

Figure D.21: Porta Praenestina From a drawing in the Cadastral Survey of Alexander VII, 1660

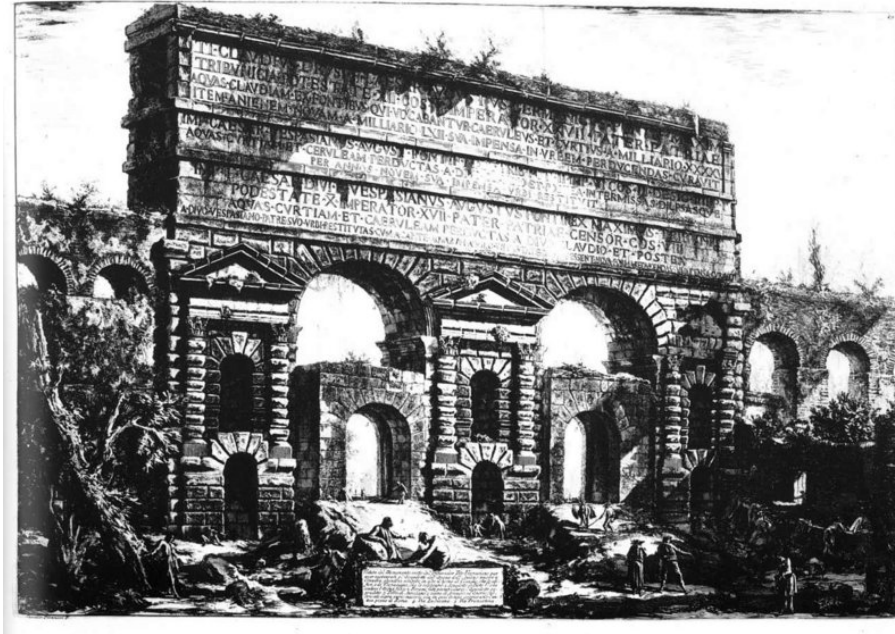

Figure D.22: Porta Praenestina by Piranesi (Ficacci, 2006)



Figure D.23: Aqua Alsietina by Piranesi (Ficacci, 2006)

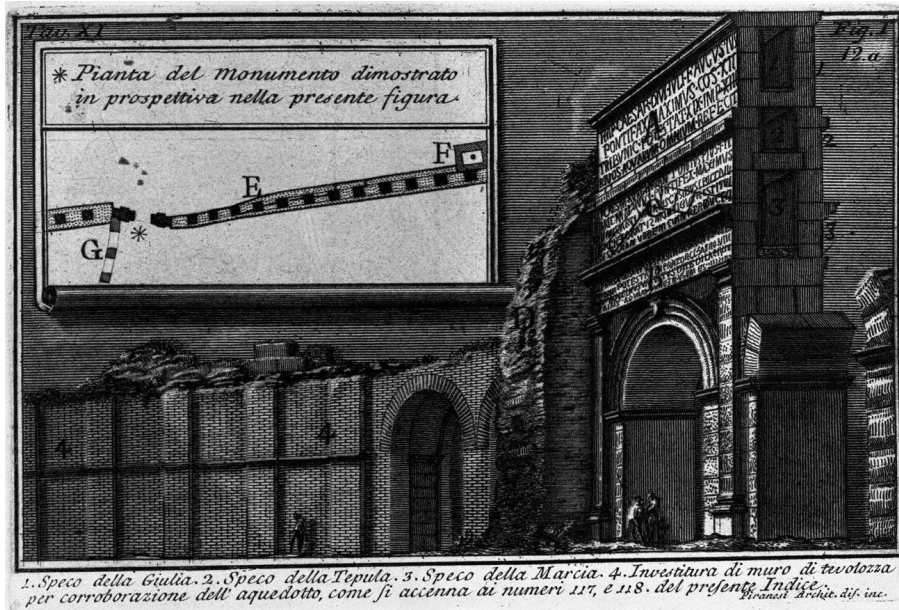

Figure D.24: Aqua Julia by Piranesi (Ficacci, 2006)

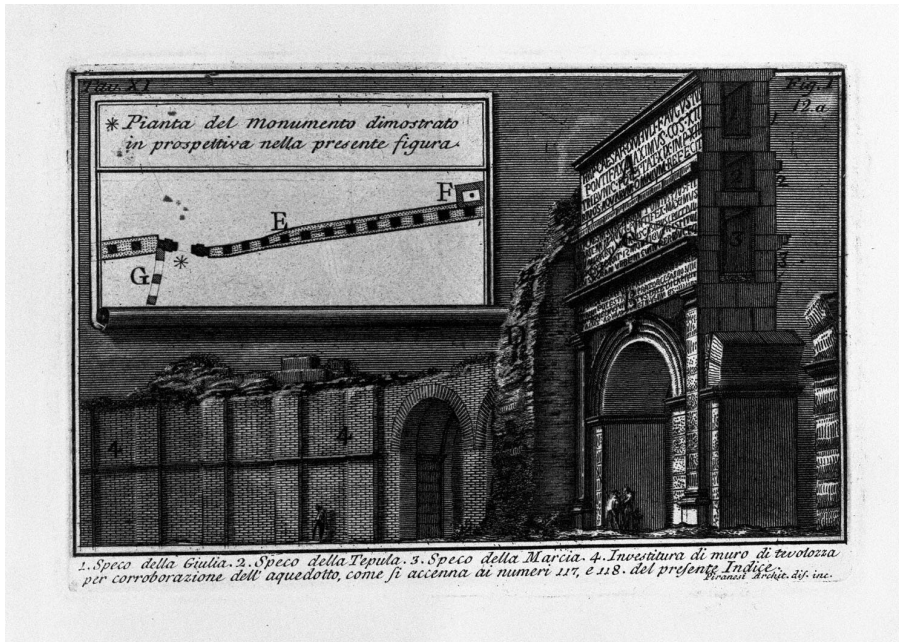

Figure D.25: Aqua Tepula by Piranesi (Ficacci, 2006)