

The pressure line of the Aspendos Aqueduct

Paul KESSENER and Susanna PIRAS*

Abstract

If not for its Roman theatre, Aspendos is probably best known for its remarkable aqueduct system serving the city. The water arrived from the mountains in the north, and crossed the wide valley between these mountains and the acropolis by means of an inverted siphon. The pipeline of this siphon was made out of perforated stone blocks, and ran over two 'hydraulic towers' before arriving at the city. It is assumed that the top of each tower was equipped with an open tank into which the water poured from the pipeline and from which the water entered the next section, dividing the pipeline into three consecutive siphons. The purpose of the hydraulic towers and the breaking up of the siphon into three parts is as yet not clearly understood. In 1996 a survey of the siphon was carried out as a first campaign of the Aspendos Aqueduct Research Program¹. In this article the results of the survey are discussed, from which conclusions may be drawn with respect to the course of the siphon and the pressure conditions within it².

1. Introduction / Prior state of knowledge

Aspendos is situated some 50 km east of Antalya in Pamphylia, about 12 km north of the southern coastline of Turkey. The acropolis lies about 60 m above sea level, on the right hand side of the waters of the Köprüçay, the ancient Eurymedon river, which was navigable up to the city in classical times and made Aspendos an important sea port. The

* (Drs. H.P.M. Kessener, c/o L&L, van Slichtenhorststraat 13, 6524 JH Nijmegen, the Netherlands; Drs. S.A.G. Piras, Groesbeekseweg 118, 6524 DL Nijmegen, The Netherlands.

¹ In order to identify the complete siphon, the course of the supplying aqueduct as well as the distribution system on the acropolis, the Aspendos Aqueduct Research Program was initiated in association with the University of Nijmegen, the Netherlands. As a first campaign the survey of the siphon by means of a theodolite was carried out in April 1996, the preliminary results of which were presented at the 19th International Symposium of Excavations, Surveys and Archaeometry, Ankara, May 26-30, 1997. The research project is supported by the Netherlands Organisation for Scientific Research (NWO), and by Pol Geotechniek at Heteren, the Netherlands, who provided the surveying apparatus.

² The survey team on site consisted of Drs. H.P.M. Kessener and Drs. S.A.G. Piras, from the University of Nijmegen, the Netherlands. We wish to express our gratitude towards the *Anıtlar ve Müzeler Genel Müdürlüğü*, for granting permission for the survey, and towards the Government representatives Mr. Edip Özgür and Mr. Ünal Çınar of the Antalya Museum, Antalya, for their help and much appreciated assistance. Furthermore we wish to thank Mr. Kayhan Dörtlük, director of the Research Institute on Mediterranean Civilisations at Antalya, and Mr. Ted Lagro, director of the Netherlands Historical and Archeological Institute at Istanbul, for their friendly help and advice.

acropolis occupies an oval, flat-topped hill, some 60 acres in extent, with steep slopes on all sides, to a height of some 30 m above the surrounding plains³. The mountains to the north begin at a distance of about 1.5 km. An extensive description of Aspendos was published in 1890 by Karl Count Lanckoronski, from which the plan, our Fig. 1 was taken⁴. As seen from a distance, the skyline of Aspendos is dominated by the remains of the façade of the nymphaeum (2nd-3rd century A.D.) and by the monumental entrance hall of the basilica, both rising to a height of some 15 m (Fig. 2). The well known Roman theatre (capacity 7500) was built against the slopes of the east side of the acropolis, and is said to be the best preserved theatre of antiquity⁵, probably due to its use as a palace by the Seljuks, who carried out conversion work and the necessary repairs⁶.

The aqueduct that served Aspendos is said to have been built in the 3rd century A.D.⁷ According to an inscription of the 2nd century A.D. a certain Tiberius Claudius Italicus seems to have spent 2 million denarii for the purpose of building an aqueduct at Aspendos⁸. The aqueduct is said to have been fed by a spring about 20 km north of the city today called "Gökçeşinar" (heavenly spring),^{9,10} which in the summer of 1979 delivered 30-40 l/sec¹¹. The water was fed to the city via a Roman aqueduct channel, typical of that period and incorporating tunnels and aqueduct bridges, although the details and the exact route of the aqueduct are today unclear. The wide and shallow depression between the acropolis and the hills, 1.5 km to the north, were spanned by means of an inverted siphon.

The siphons in Roman aqueducts have been the subject of extensive studies and discussions¹². Water was carried across the valley under pressure in a closed pipeline, according to the natural principle of 'water finding its own level' (Fig. 3). The Romans were well aware of this concept in contrast with the until recently widespread belief to the contrary, although the principle is stated by Pliny: '*(aqua) subit altitudinem exortus sui*'¹³. The material used to manufacture the pipes of these siphons varied: lead, stone, concrete and ceramics/terracotta are known to have been used. Though no known expression exists in Latin for (inverted) siphon, several technical terms describing parts of it are mentioned by Vitruvius, such as *geniculus*, and *venter* (*κοιλια*). It is assumed that the Romans incorporated siphons in their aqueducts for calculated and rational (economic) reasons. They pre-

³ J.B. Ward-Perkins, "The Aqueduct of Aspendos", BSR 23, 1955, 115-123.

⁴ K.G. Lanckoronski, Städte Pamphyliens und Pisidiens (1890) 85-124.

⁵ E. Akurgal, Ancient civilisations and ruins of Turkey (1970) 334-5.

⁶ J. Wagner, Türkei: die Südküste von Kaunos bis Issos (1986) 178.

⁷ Ward-Perkins, op. cit. 122.

⁸ G.E. Bean, Turkey's southern shore (1979). 53; IGRP III, 804.

⁹ M. Kütükçüoğlu, Güney Anadolu Tarihi Su Tesisleri, Antalya Havzası (1962) 24-42.

¹⁰ G. Büyükyıldırım, Antalya Bölgesi Tarihi Su Yapıları (1994) 153 ff.

¹¹ G. Garbrecht (ed.), Die Wasserversorgung antiker Städte (1987) 173.

¹² e.g. N.A.F. Smith, Attitudes to Roman Engineering and the question of the Inverted Siphon (1976) Vol. I, 45-71; H. Fahlbusch, "Vergleich antiker griechischer und römischer Wasserversorgungsanlagen", Mitt. des Leichtweiss-Institut für Wasserbau 73, 1982, 1 ff.; A. Trevor Hodge, "Siphons in Roman Aqueducts", BSR 51, 1983, 174-221; A. Trevor Hodge, Roman Aqueducts and Watersupply (1992) 147 ff.

¹³ N.H. XXXI, 57

ferred to build bridges up to 50 m in height, but for crossing valleys of greater depth they used siphons¹⁴.

The siphon of the Aspendos aqueduct runs from the mountains 1.5 km away to the acropolis in a north-south direction. It is distinguished by two 'hydraulic towers', which are incorporated into it, giving the siphon its peculiar appearance. The towers are located at horizontal bends in the course of the siphon. According to the data of Lanckoronski, the angle of these bends is 55 degrees, at the south tower close to the acropolis, and 12 degrees at the north tower. The distance between the top of the two towers is 924 m, the pipeline is carried over the main valley on a conventional arched bridge 5.5 m wide and 550 m in length, 29 of the arches were standing in Lanckoronski's time (Fig. 4). The bridge is 15 m high at the deepest point of the valley, and presumably served also as a road bridge¹⁵. The course of the siphon of Aspendos is clearly known only in between the two hydraulic towers, neither header tank nor receiving tank had as yet been identified. No information is available as yet on the pressure conditions reigning in the pipeline and its relation to the building of the two towers.

2. Survey

As a first campaign, the survey of the siphon by means of a theodolite (Nikon NTD-4) was carried out in April 1996. Our first aim was to inspect the remains of the several parts of the siphon and to identify the header tank and the receiving tank.

The towers

The attention of the visitor to the Aspendos siphon is drawn to the towers, marking the plain between the acropolis and the hills in the north. The towers are at present some 30 m high. They are almost identical, except for the change in direction of the ramps leading up to the tops of the towers. The lower part of the central towers are constructed of dressed stone, the upper part is of brick. Lanckoronski interpreted the variety of materials used in the towers to be the result of restoration works¹⁶, but Ward-Perkins has shown that the surviving remains are all part of the original building¹⁷. The central towers are equipped with a spiral staircase some 90 cm wide, accessible by means of a door, with an opening 1 m wide and 1.90 m high, in the south tower. This door is located 3 m above the present ground level. The dimensions of the base of the south tower at the height of the door opening are shown in Fig. 5. The staircase inside the squared stone part of both towers are still intact, climbing to a height of 17 m. The walls of the central towers are 125 cm wide, the staircase spirals around a square central pillar (1.20x1.20 m). The interior of the towers measures 3.00x3.00 m (Fig. 6). The steps, three per side, are made from large stone cuttings bridging the 90 cm wide gap between the central pillar and the interior wall. The height difference for one turn of 360 degrees is 3.60 m, i.e. 30 cm per step, not a very

¹⁴ Smith, op. cit. 45 pf.; Hodge 1992, op. cit. 147 pf.; Hodge 1983, op. cit. 174 ff.

¹⁵ Ward-Perkins, op. cit. 119.

¹⁶ Lanckoronski, op. cit. 124.

¹⁷ Ward-Perkins, op. cit. 121.

convenient height for climbing these stairs. The walls not adjoining the ramps are equipped with longitudinal openings, about 0.30x1.00 m, allowing air and some light into the interior of the towers.

Above a height of about 17 m, where the building material of the central towers changes from squared stones to bricks, the walls of the towers not adjoining the ramps are largely destroyed¹⁸. The intact walls on either side show the remains of brick vaulting partly incorporated in it, three vaults in a row, two with the axis of the arch parallel to the wall and positioned one above the other, a third vault positioned above the other two with its axis perpendicular (Fig. 7). The bricks used for these vaults are identical to those found in the walls. In the south tower these arches are semicircular in shape having an internal diameter of 90 cm. In the north tower the corresponding arches of a larger diameter span a similar gap. One observes the remains of up to three of such series of vaults above each other in each tower.

Of the middle vaulting, the part not incorporated into the wall obviously rested on the central pillar which was the continuation of its counterpart in the dressed stone part of the tower. This continuation was also made of brick. The piers of the neighbouring arches rested on top of the middle vaulting positioned below. Thus a sequence of brick vaulting spiraled upward, on top of which the staircase was made to continue in the brick part of the towers (Fig. 8). Traces of the steps were observed on the walls above these vaults. Thus the towers were accessible by means of a staircase leading to the top. We did not notice any remains of a water tank or of *opus signinum*, but we saw a layer of calcareous incrustation 0.5 cm wide on the inner west wall of the south tower, at a height of 19-20 m above ground level, indicating the spillage of water from above.

The overall construction and material of the towers and the adjoining ramps, and of the piers of the two-tier bridge connecting the south tower to the acropolis are described by Ward-Perkins:¹⁹

“One of the most singular features of these unusual structures is the great variety of material used in their construction. The lower part of the central tower and the piers of the adjoining arches are of squared stone, identical with that of the main bridge. The upper part of the tower is, on the other hand, is of brick; and whereas the two pairs of tall arches on either side of the tower have stone voussoirs, the remaining arches are all of brick. The ramps themselves, where they are not pierced by arches, and certain parts of the arched structure are built in a hard, mortared rubble, resembling concrete, which is separated at more or less regular intervals by courses of brick, and which is brought to a vertical face by means of small, irregular blocks of stone, hand-laid and liberally mortared to produce a smooth, compact surface. All three types of masonry are also seen in the bridge that links the south tower to the citadel, with an additional variant in the upper of the two order arches, the piers of these are built of the same mortared rubble, but with additional quoins of brick.”

¹⁸ The bricks, dimension 60x30x5 cm and of excellent quality, are cemented together by layers of mortar 1-2 cm wide.

¹⁹ Ward-Perkins, op. cit. 120.

The tops of the towers have been destroyed²⁰. The upper brick parts of the central towers show large vertical gaps in the walls not adjoining the ramps, down to the level of the lower square stone part, these gaps being more or less similarly shaped for both the north and south tower. Although the destruction of the towers is considerable, their degradation does not seem to relate directly to the time that has elapsed since their construction, as a comparison of the condition of the north tower recorded on a photograph taken in 1911 with its present state reveals (Fig. 9,10)²¹. In 85 years the aspect of the tower hardly appears to have changed, a token of the excellent quality of the building material, but is also an indication that a sudden event perhaps an earthquake caused severe damage to both towers simultaneously, disrupting the siphon.

The south tower is located some 130 m from the steep north-western slopes of the acropolis, and is linked to it by a double arcade bridge. The top of this bridge ran at an intermediate level between the main bridge and the tops of the towers. Ward-Perkins suggested that the receiving tank of the siphon 'must have lain beyond the summit of the acropolis, at some point suitable for distribution to the city's public bath-buildings on the low ground to the south-east', and conjectured that 'some part of the huge system of cisterns underneath the agora and the basilica may have been planned in connection with the building of the aqueduct'²². Fahlbusch however concluded that the aqueduct should have ended at the nymphaeum on top of the acropolis²³. The map of Lanckoronski shows the course of the siphon arriving from the south tower at the edge of the acropolis. It continues, after making a turn of about 80 degrees, in a south-easterly direction for some 130 m, ending a considerable distance away from the nymphaeum without arriving at any clear distribution point (see Fig. 1).

The piers of the two tier bridge are still standing today, all the arches except one being destroyed. Counting from the south tower, the surviving arch spans the gap between piers no.7 and 8. Of a total of 14 piers, the first 6 were connected by double arches, the remaining piers being built on the higher level, on the slope leading to the steep edge of the acropolis. The bases of piers 6, 7 and 8 are interconnected by a wall to the level of the lower arches. The 13th pier is different from all others: its base is about 7 m long, and it is made of mortared rubble interlaced with horizontal courses of brick (Fig. 11). It is

²⁰ As was the case in Lanckoronski's time: "Die beiden Thürme zu Aspendos erheben sich etwa 30 m hoch über dem Boden, oben sind sie zerstört", Lanckoronski, op. cit. 121.

²¹ The 1911 picture was taken by S. Fikri Ertem, founder of the Antalya Museum. It was kindly put at our disposal by Mr. Dörtlük, director of the Research Institute on Mediterranean Civilisations at Antalya.

²² Ward Perkins (op. cit. p.118, n.8) deduces from the figures of Lanckoronski the approximate height of a conjectured receiving tank with respect to the other elements of the siphon (Ward-Perkins, 8): "From the figures given by Lanckoronski the approximate heights above sea-level of the various elements can be calculated as follows (disregarding a slight fall along the aqueduct from north to south):

Top of pressure towers	61 m
Water-channel of main bridge	30 m
Water-channel of final sector	47 m
Receiving-tanks in the Agora	55 m
Bath-buildings	30 m

²³ As cited from Garbrecht 1987, op. cit. 174: "Die Wasserleitung endete auf der Akropolis anscheinend in einen Nymphaeum. Als solches wurde es durch Vergleich mit dem entsprechenden Bauwerk in Side identifiziert, da weder die ursprüngliche Ausstattung noch die Verbindung mit der Wasserleitung erhalten sind."

shaped like a wall, with at either end traces of an arch extending towards piers no.12 and 14 respectively. Pier no.14 is constructed directly against the vertical edge of the acropolis which is about 7 m high at this point. Here we searched for a tunnel or a possible underground route for the pipeline as suggested by Ward-Perkins²⁴. No indication whatsoever at this point or in the surrounding area could be discovered. Clearly the pipeline should have followed an elevated course if it were to supply the acropolis and the nymphaeum with running water.

Receiving tank

In line with the double arched bridge, and located on the acropolis about 15 m from its steep edge, the remains of a square tower may be observed. Its position corresponds with the change in direction in the course of the siphon on Lanckoronski's map. The remains are presently 4.5 m high. This tower, constructed of mortared rubble dressed with square stones, is essentially rectangular (1.8 m x 2.35 m) and is equipped with two extensions. Its base, nearly level with the top of the south tower, has an extension towards the south tower measuring 1 m x 1.75 m, on top of which an arch was constructed, impressions of a double layer of bricks in mortar are visible, with part of one brick *in situ* (Fig. 12). The reconstructed diameter of this arch is about 5 m. In the direction of the course of the siphon as it continued at the edge of acropolis on Lanckoronski's map, the tower has a second extension, 120 cm wide and not as long. To this side, the top of the tower also shows evidence of an arch, with an estimated diameter of 3 m, its extrapolated top is projected to rise 5.4 m above the base of the tower. The distance spanned by this arch corresponds with the position of the remains of a subsequent rectangular pier 3 m to the west of the tower, similar remains are to be found along the route drawn by Lanckoronski. Speculating that there was an open aqueduct channel which was supported by arches, we reconstructed the approximate level of the floor of the channel at 5.9 m above the base of the tower, allowing for a thickness of 0.5 m of material on top of the arches. This level turned out to be some 3 m above the highest ground level to be found on the acropolis. Such an open aqueduct channel would have served the whole city. Could it also have supplied the nymphaeum?

The nymphaeum in its present state consists essentially of a wall 1.5 m thick, 35 m in length and 15 m high (Fig. 2). At the front, at the bottom and to the right side of the central niche, we observed two large terracotta pipes having a diameter of about 40 cm, these were probably drains for the water basins of which today no trace remain. Abundant signs of the application of *opus signinum* were observed. At the back of the nymphaeum, the recess corresponding with the central niche harbours two stone elbow joints. These have an aperture of 25 cm, with traces of calcareous deposits on the inside, indicating that water arrived at the nymphaeum under pressure (Fig. 13). A horizontal recess running at an intermediate level from the right side of the nymphaeum to the upper part of the central niche may also be observed, a suitable location for a conduit that supplied an ornamental fountain spout from above (Fig. 14). It turned out that the floor level of the conjectured open channel is 0.5 m above this horizontal recess, which is a strong argument for the siphon

²⁴ Ward-Perkins, *op. cit.* 118.

ending at the square tower at the edge of the acropolis, the tower thus serving as the receiving tank for the siphon.

Fig. 15 shows the plan of the two tier bridge between the south tower and the receiving tank. The overall distance between the central part of the south tower and the receiving tank is 154 m. In Fig.16 the relative heights of the remains of the pier no.13 and 14 and of the receiving tank are depicted, as well as a reconstruction of the ramp carrying the pipeline up to the receiving tank. The angle from the horizontal, is about 30 degrees, and is similar to the angle of the ramps leading to the top of the hydraulic towers.

The level to which the water must have been brought is about 6 m above the present top of the south tower. It was pointed out that these towers were built higher than they are at present, as the present remains of the brick staircases inside the towers continue all the way to the existing top. An open tank located on the top of the south tower should have been positioned above the receiving tank if water were to flow into it in at a significant rate and quantity. This applies to the north and the south tower as well: if they were equipped with open tanks, the tank on top of the north tower must have been positioned higher than its counterpart on the south tower. The header tank for the siphon should have been positioned at a level somewhere above the receiving tank.

Header tank

The north tower, which lies 924 m north of the south tower, marks the point where the course of the siphon makes a slight turn towards the east. It is built on a slight rise in the terrain, about 15 m above the central valley crossed by the large venter bridge. One can reach the north tower by car by following a small road to the east of the course of the siphon. The tower is located about half a kilometer from the northern hills, and about half a kilometer from the Eurymedon river which lies to the East.

Departing from the north tower in the direction of the north ramp, we noticed after proceeding for some 200 m on a narrow road leading to Sariabali village the remains of a wall on the west side of the road which had been employed as a foundation for the road. About 100 m further on a degraded mortared rubble wall emerged on the east side of the road. This wall is about 70 m long, increasing in height to over 3 m in relation to a slight depression in the terrain. Subsequently the wall was seen to continue as a bridge, remains of eight piers, 2.4 x 2.5 m square, with a maximum height of 3 m and an interdistance about 4.5 m, are standing today (Fig. 17). The most northerly pier is located about 20 m away from the foot of the first hill leading up to the mountains, subsequent piers have been destroyed due to the construction of the road which crosses the course of the bridge at this point. At the foot of the hill we discovered the remains of a wall 2.4 m wide, in line with the bridge and covered by erosion material from the hill. After superficially cleaning it from debris a clearer view of its outline came to light, as is shown in Fig. 18.

The hill at this point has a steady slope of about 30 degrees, rising to about 80 m above sea level, 50 m above the plains to the south. Its top is flat and shaped like a triangle, the top angle pointing south. On the southern edge of the hill we discovered the remains of two parallel walls 1 m wide and 2.5 m in length, rising about 1 m in height. The western wall appeared to be equipped with an opening at ground level, 30 cm square, the sides covered by calcareous incrustation (sinter) about 1 cm in thickness, proof that water has been flowing through this orifice (Fig. 19). There are indications that the walls were inter-

connected at the ends, suggesting a 2.5 m square container or tank-like construction. On the cultivated field at the top of the hill we came across numerous remains of aqueduct lining cement (*opus signinum*), some in 30 x 45 cm² plaques 6 cm wide, covered with layers of sinter up to 1 cm in thickness. The local farmers confirmed that an aqueduct channel did run over the top of the hill in earlier times, but its remains were removed because it interfered with the cultivation of the field. The walls on the top of the hill can be regarded as the arriving point of the conventional aqueduct channel: the header tank to the subsequent siphon. The opening in the side of the west wall would probably have served as an overflow orifice. A reconstruction of the header tank is shown in Fig. 20. Its level should exceed that of the top of both of the towers as well as of the receiving tank.

The siphon

We then surveyed the complete siphon using the Nikon NTD-4. About 1000 points were taken from 3 theodolite locations. In Fig. 21 the extracted spatial coordinates are projected on a horizontal plane, revealing the course of the siphon including the bends at the south tower (55°) and at the north tower (16°). The course between the header tank and the north tower appears to be slightly curved. The points 'Q' west of the north end of the main bridge relate to a quarry, which was used to supply the conglomerate material for the construction of the bridge and the towers, as were the rocky outcrops nearer to either bridge ending. From this data we were able to reconstruct the course of the siphon schematically as is shown in Fig. 22. The overall length of the siphon is 1670 m (154 m + 924 m + 592 m).

Fig. 23 shows the theodolite data plotted on a vertical plane (height vs distance in a 1 to 1 ratio), the horizontal axis representing the distance along the course of the siphon. As expected both towers appear small, but discernable, in relation to the length of the siphon. Scaling the vertical axis by a factor of 20, the separate elements of the siphon are recognized more distinctly, as is shown in Fig. 24. The hydraulic gradient line between the header tank and the receiving tank extends well over the present tops of the towers. The header tank is 14.5 m above the projected floor level of the receiving tank. From the header tank downwards, on the slope of the hill towards the first *geniculus*, no archeological remains of a ramp or foundation for the stone conduit could be identified, the corresponding points in Fig. 24 indicate only the present ground surface.

If the towers were equipped with open tanks, then their tops should have reached up to the hydraulic gradient line. This would mean that the south tower would have been about 37 m high, rising some 7 m above its present level, while the north tower would have attained a height of 40 m. This is shown in Fig. 25, which shows a schematic profile of the siphon in which the present heights of the towers are indicated as well as their heights corresponding to the hydraulic gradient line. If we assume the position of the overflow orifice in the wall of the header tank to set the maximum water level at the starting point of the siphon, the static pressure in the pipeline would not have exceeded 45 m of column water²⁵.

²⁵ Although water has flown through it, the orifice does not necessarily have to coincide with this level, as the start of the siphon may have been positioned lower. To verify this, the remains of the header tank should be inspected more closely, including the removal of the accumulated soils in and around it, which is planned in the 1998 campaign.

From the Darcy-Weisbach formula for flow of water in a closed conduit one may calculate the mean velocity, V , for water transported by the Aspendos siphon:²⁶

$$V^2 = (8g/\lambda) * (Rh * \Delta H/L)$$

where g = gravitational constant (9,81 m/sec²)

Rh = hydraulic radius of the pipe

(= $D/4$ for a filled conduit, D = diameter of the pipe = 0.28 m)

ΔH = difference in water level between header tank and receiving tank (= 14.5 m)

L = length of siphon (= 1670 m)

λ = factor depending on roughness of the interior wall of the pipeline

(for the Aspendos stone pipe elements: $\lambda \approx 0,043$)

Disregarding the additional length of the pipeline due to the sloping of the ramps, and disregarding the minor effects caused by the bends in the pipeline (*geniculi*) and by the inlet and outlet orifices at the header tank, the receiving tank and at the tanks on the top of the towers, it follows:

$$V = 1.05 \text{ m/sec.}$$

The discharge Q of the siphon, the maximum volume of water that could be delivered to the acropolis, equals $V * A$, A being the cross section of the pipeline in m² ($A = \pi * D^2/4$)

$$Q = 1.05 * \pi * (.14)^2 \text{ m}^3/\text{sec} = 65 \text{ l/ sec} = 5.600 \text{ m}^3 \text{ per 24 hour day.}$$

The capacity of the siphon was clearly sufficient to handle the 30-40 l/sec debit of 1989 of the Gökçeşinar spring (see above, note 12). The capacity of this well may have been larger in classical times, we might also consider that more than one spring fed the aqueduct. Supposing a daily consumption of 300-500 liters per head per 24 hour day, a generous but not unusual figure, we may estimate the population of Aspendos in the 2nd-3rd century AD. to have been 11.000-18.000 persons²⁷.

The loss of head-pressure for the Aspendos siphon amounts to 14.5 m over a length of 1670 m, that is 8.7 m/km. This value takes an intermediate position within the range of some known hydraulic gradients for classical siphons, as is shown in the table.

The pipeline of the Aspendos siphon was made from perforated limestone blocks measuring some 85 x 85 x 50 cm, having a bore with a diameter of 28 cm, and equipped with socket and projecting flange for proper joining²⁸. Ward-Perkins did not see any of these blocks at the site of the siphon, reproducing Lanckoronski's drawing in his article²⁹. Kütükçüoğlu and Fahlbusch published early photographs of stone pipe segments originating from the Aspendos siphon³⁰. A considerable number of perforated stone blocks are

²⁶ See e.g. *Hydraulica*, WL, Dutch Laboratory for Hydraulics, (1993).

²⁷ Hodge 1992, op. cit. 305. 464 n.4; Stenton, E.C. - Coulton, J.J., in: "Oinoanda: The watersupply and aqueduct", *AnatSt* 36, 1986, 55 n. 146, cite figures varying from 160-190 l./pers./day for Pergamon, 520-900 l./pers./day for Rome, to as high as a 1000 l./pers./day for Trier.

²⁸ Lanckoronski, op. cit. 124 Fig. 89.

²⁹ Ward-Perkins, op. cit. 119 Fig. 2: but leaving out the round vertical hole leading from the pipe inside to the outer surface on the joint between two blocks which does appear in Lanckoronski's drawing.

known have been used as building material for the Selçuk bridge over the Eurymedon 2 km south of the Aspendos acropolis, built on the ruins of a much larger Roman bridge (Fig. 26)³¹.

Place	Aqueduct	Siphon	Maximum depth (m)	Hydraulic gradient (m/km)
Lyon ³²	Gier	St. Irénée (Trion)	30	2.6
Lyon ³³	Mont d'Or	d'Ecully	70	3.1
Lyon ³³	Gier	Beunant (l'Yzeron)	123	3.1
Lyon ³⁴	Craponne	Tupinier	30	3.8
Lyon ³⁴	Brévenne	Grange-Blanche (Ecully)	89	6.4
Lyon ³⁴	Gier	St. Genis (la Durèze)	78	6.7
Lyon ³⁴	Craponne	Tourillons	90	7.3
Lyon ³⁵	Gier	Soucieu (le Garon)	93	8.3
Aspendos	Aspendos	Aspendos	45	8.7
Pergamon ³⁶	Madradağ	Pergamon	190	12.6
Oinoanda ³⁷	Oinoanda	Oinoanda	22	13.3
Patara ³⁸	Patara	Delik Kemer	20	18.5
Lyon ³⁹	Mont d'Or	Cotte-Chally (R.Limonest)	30	19.0
Laodikeia a/L ⁴⁰	Laodikeia	Laodikeia	50	26.3

Table 1. Maximum depths and hydraulic gradients of some classical siphons.

³⁰ Kütükçüoğlu, op. cit. 30, Table 2; Falsbuch, op. cit. 85, Fig. 49.

³¹ Garbrecht, op. cit. 173. A larger number of these conduit stones are also to be found in the remains of the Roman bridge, on which the Selçuks built their bridge over a 1000 years later. This indicates that the Romans constructed the earlier bridge after the aqueduct and its siphon had become disused for some reason, using the conduits stones as spolia. A survey of the Selçuk bridge and its Roman counterpart within the scope of the Aspendos Aqueduct Research Program is planned for spring 1998.

³² Smith, op. cit. 60.

³³ J. Burdy: "Some direction of future research for the aqueducts of Lugdunum (Lyon)": Future currents in Aqueduct Studies, 1991, 29-44.

³⁴ Smith, op. cit. 60.

³⁵ Burdy, op. cit. 29 ff.

³⁶ Fahlbusch, op. cit. Fig.42.

³⁷ Stenton-Coulton, op. cit. 34-5.

³⁸ Observation by author, 1996.

³⁹ Burdy, op. cit. 29 ff.

⁴⁰ G. Weber, "Die Hochdruck-Wasserleitung von Laodikeia ad Lycum", JdI XIII, 1898, 1-13.

Searching at the site of the siphon, we spotted a conduit stone incorporated in the wall of an old farm house west of the two tier venter bridge, another was found lying 10 m west of the base of the central part of the south tower, while two further blocks were found buried alongside the south ramp of the south tower. Between the header tank and the north tower another 10 perforated stone blocks were found scattered along the course of the siphon. Some of these stones are equipped with a funnel shaped hole leading from the inside of the pipe to the outer surface, in one case on the joint as was described by Lanckoronski (Fig. 27). Similar perforating holes in stone pipe blocks ("vent holes") have been found elsewhere, e.g. at the siphon of Laodikeia a/L, the stone pipeline at Susita, the Delik Kemer siphon at Patara⁴¹. These holes were normally closed off with stone plugs fitted with plaster, a specimen of which is to be seen at Ankara today (Fig. 28)⁴². Similar holes are known to exist in terracotta pipelines⁴³. The purpose of these holes is not clear; it has been suggested that the holes served as drain cocks to empty the system when maintenance was required, or as rodding holes for clearing blockages⁴⁴. Also they possibly served as safety valves, the plugs were intended to blow off if there was a dangerous pressure surge⁴⁵. Fahlbusch in his turn suggested the holes were cut into the pipes to enable the removal of calcareous incrustations by means of hot vinegar⁴⁶. Some associate the holes with Vitruvius' *collivaria* (see below)⁴⁷.

Assuming the towers incorporated in the Aspendos siphon were equipped with open tanks on top, into which the water flowed from the pipeline and from which the water left again into the next section, the siphon would have been divided into three consecutive siphons. As the towers are located at the bends in the course of the pipeline, the forces exerted by the water on the pipeline at the bends would have been effectively eliminated⁴⁸. The towers would also allow air to escape from the pipeline, some consider this to be the reason for their construction⁴⁹. The Aspendos towers have been associated with a similar device at Les Tourillons de Craponne, France, incorporated in the Yzeron aqueduct of Lyon, although in this case apparently no horizontal bend in the course of the siphon occurs⁵⁰.

41 Laodikeia a/L: Weber, op. cit. 1 ff.; Susita: Peleg, Y.: "Ancient pipelines in Israel", *Future currents in Aqueduct Studies* (1991) 129-148; Patara: Stenton - Coulton, op. cit. 50-51.

42 Weber, op. cit. 6.: "In Pergamon hat Gräber dieselbe Beobachtung gemacht, ja sogar das Glück gehabt noch einen runden Stein in das Loch eingepasst und die Fuge mit Kalkmortel vergossen vorzufinden" The writer of the present article saw the pipe element with stone plug *in situ* at the Ankara Roma Hamam Museum.

43 Tölle-Kastenbein, R., "Entlüftung antiker Wasserleitungsrohre", *AA* 1991, 25-30.

44 Hodge 1992, op. cit. 37-9.

45 Stenton - Coulton, op. cit. 50-51.

46 H. Fahlbusch, "Überlegungen zur Möglichkeit der chemische Entsinterungen von Druckrohren im Verlauf römischer Fernwasserleitungen", *Mitt. des Leichtweiss-Institut für Wasserbau* 103, 1989, 219-245.

47 See for a general discussion: Hodge 1992, op. cit. 37 ff, 154 ff; also Tölle-Kastenbein, op. cit. 25 ff.

48 By completely getting rid of the bends; but might this problem not have been solved in a simpler and cheaper way, e.g. by counter weights or sand ballast?

49 e.g. Garbrecht, op. cit. Hodge 1992, op. cit. 160. Air entrapped in the closed pipeline of a siphon may impair its functioning. But why build two towers in a row? Many larger and deeper Roman siphons are known to have functioned without any towers at all.

50 J. Burdy, *L'Aqueduc Romain de l'Yzeron*, (1992) 90 ff. In this case, the tower is built on top of a rise in the terrain, which could not be avoided. On the other hand, the Pergamon siphon has two intermediate high points but no towers (see note 33).

The towers of the Aspendos siphon are associated with the hapax legomenon *colliquiaria* or *colliviaria* mentioned by Vitruvius (Book VIII, Chapter 6): "*Etiam in ventre colliquiaria sunt facienda, per quae vis spiritus relaxetur*". This sentence is translated by Fensterbusch as "Auch muß man in den Bauch Kolliquarien anlegen, damit durch sie die Luftdruck gemindert wird": *colliquiaria* are to be built in the venter in order to reduce the air pressure⁵¹. A recent account of the current interpretations of this expression is given by Fahlbusch and Peleg⁵², relating the *colliviaria* also with the secondary castella at Pompei, the suterazi of the Ottoman waterworks at Akko and at Constantinople, and with some devices found in the aqueduct of Caesarea (Israel). The purpose of the *colliquiaria* is said to relieve forces resulting from waterpressure and inertial thrust (e.g. Aspendos, les Tourillons, Caesarea, suterazi), and from shockwaves caused by sudden closure or opening of the watertaps (Pompei), while allowing air to escape from the water (see also Tölle-Kastenbein⁵³). Hodge however associates *colliquiaria* with draincocks for emptying the siphons⁵⁴, possibly for the purpose of maintenance and cleaning, an opinion clearly disputed by Fahlbusch *et al*⁵⁵. There is no *communis opinio* as to what the meaning of the expression *colliquiaria* is, nor what these devices were used for. As for the towers of Aspendos, Hodge stated that "to me, the true explanation of the Aspendos 'pressure towers' remains a puzzle"⁵⁶.

3. Conclusion

The Aspendos Siphon now has been surveyed, and its overall profile is known, be it that some uncertainty still remains as to the exact location of the start of the siphon. The reason for the building of the towers is not as yet clear, but using the new data theoretical calculations and if necessary scale experiments are to be conducted at the Dutch Laboratory for Hydraulics at Delft, the Netherlands, in an attempt to shed some more light on this and the relation between the towers and Vitruvius' contested sentence.

For the future we envisage the following research on site :

- Investigation of the header tank at Sariabali village: what is the exact location and elevation of the start of the siphon, can we trace the ramp that carried the pipeline downward on the slope of the hill, and what is the location of the first *geniculus* at the bottom of the hill?

- Supplying aqueduct: where did the water come from, what is the exact course of the aqueduct, how many bridges and tunnels were incorporated in it?

51 C. Fensterbusch, *Vitruvii De Architectura Libri Decem* (1964) 397. H. Morgan, *Vitruvius, The Ten Books on Architecture* (1960). 245, translates *colliquiaria* as "watercushions" without explaining what he means by it. F. Granger, *De Architectura*, (1962) Vol 2, .185 n.11, uses the word "standpipes". Smith, op. cit. 58, thinks of *colliquiaria* as air valves.

52 H. Fahlbusch - J. Peleg, "Die Colliviaria Vitruvs, Möglichkeiten der Interpretation", *Mitt. des Leichtweiss-Institut für Wasserbau* 117, 1992, 105-140.

53 Tölle-Kastenbein, op. cit.

54 Hodge 1992, op. cit. p.154.

55 Fahlbusch - Peleg, op. cit.

56 Hodge 1992, op. cit. 445 n.51.

- Course of aqueduct on the acropolis: what was the relation between the aqueduct channel on the acropolis and the nymphaeum? Did the aqueduct end somewhere at a *castellum divisorium*, from where the bath buildings south of the acropolis were also supplied?

- Survey of the Seljuk Bridge: where did the pipe elements of the Aspendos siphon go, how did the Seljuks make use of the ruins of the earlier Roman bridge to construct their bridge? We estimated the number of stone pipe elements used for the siphon to be about 3400 pieces. Some 250 were seen in or near the Seljuk bridge, which, including the 15 stone blocks that we counted along the course of the siphon, amounts to less than 8 per cent. The Seljuk bridge however may harbour many more pipe elements than were spotted by this quick inspection.

Özet

Aspendos Su Kemerleri Su-Basınç Hattı

Antik Aspendos kenti, ünlü Roma tiyatrosunun yanında benzersiz su kemerleriyle de tanınır. Kuzeydeki dağlardan gelen şehir suyu, bu dağlar arasındaki geniş vadiden ve akropolisten "sifon sistemi" (teknigi) ile geçirilir. Bu sisteme göre, içiçe geçmeli taşlardan yapılmış sifonun künk hattı şehre ulaşmadan önce iki ayrı "hidrolik kule" aşar. Tahminlere göre, her kulenin tepesinde suyun boşaldığı ve diğer bölüme aktığı açık bir "tank" vardır. Tanktan sonra künk, 3 sifona bölünür. Hidrolik kulelerin amacı ve neden üç sifona bölündüğü henüz tam anlaşılamamıştır.

1996 Aspendos Su Kemerleri Araştırma Programı'nda sifonun yüzey araştırması ve ölçümlemesine yönelik çalışmalar yapılmıştır. Bu makalede de ortaya çıkan sonuçlar anlatılmaktadır. Kulelerin yapım amacıyla ilgili henüz kesin yargıya varılmış olmasa da, kuramsal data hesaplamaları ve gerektiğinde Hollanda Delft'teki Dutch Hidrolik Laboratuvarı'nda yapılacak ölçüm denemeleri, soruna ve Vitruvius'un tartışmalı görüşlerine ışık tutabilecektir.



Figure 1 Plan of the Aspendos acropolis (Lanckoronksi). The aqueduct (siphon) arrives at the acropolis from the north ('k' on the inset).



Figure 2 Façade of the nymphaeum on the acropolis of Aspendos.
To the right: entrance hall of the basilica.

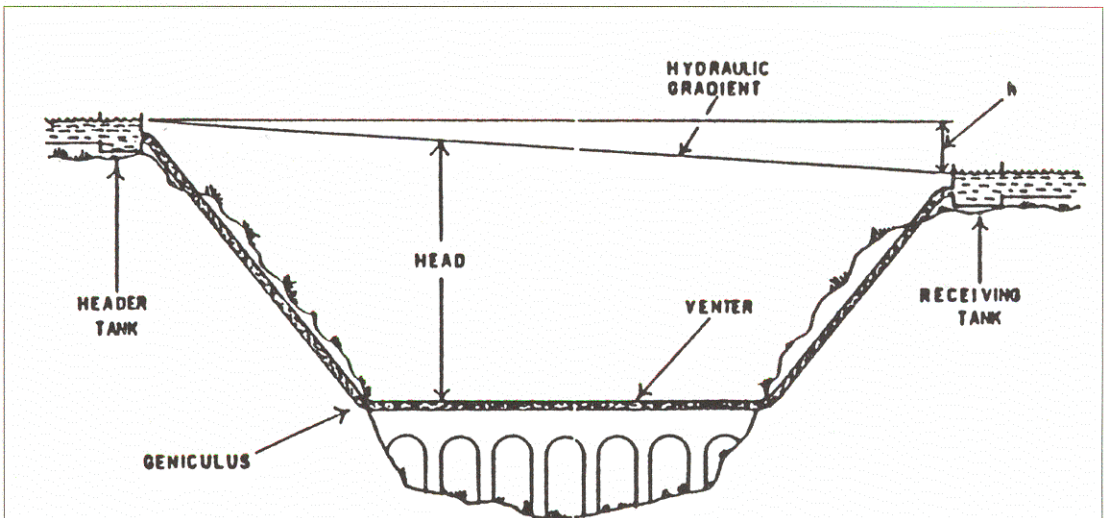

Figure 3 Diagram of a typical inverted siphon (Hodge 1992). The water arrived at the header tank by means of a conventional aqueduct channel, and crossed the valley through a piped conduit, descending on one side to the bottom of the valley, the lowest part of which was normally cut off by a bridge (*venter*), and ascending up the otherside to the receiving tank, from where the water was fed into an aqueduct channel again.

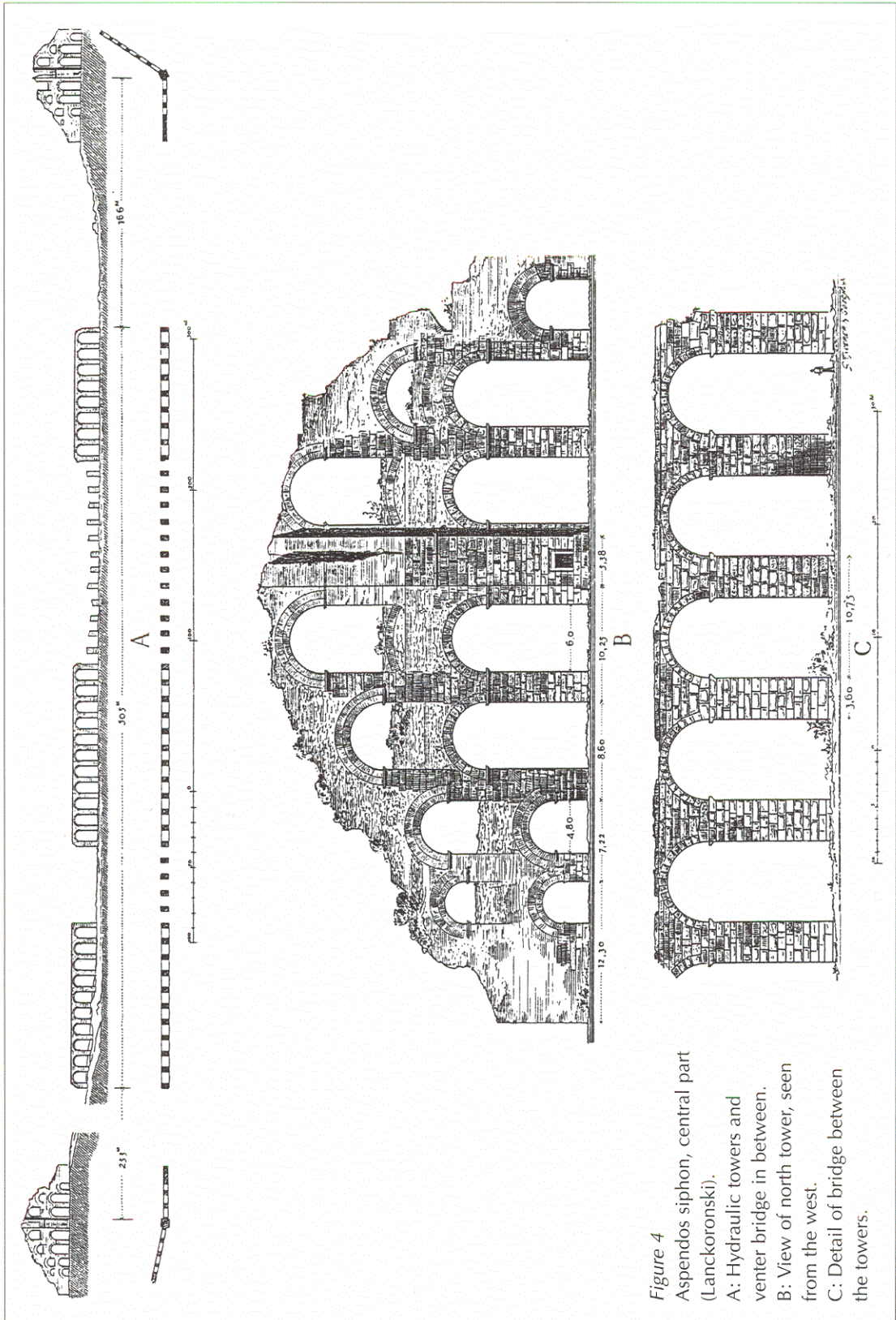

Figure 4
 Aspendos siphon, central part (Lanckoronki).
 A: Hydraulic towers and venter bridge in between.
 B: View of north tower, seen from the west.
 C: Detail of bridge between the towers.

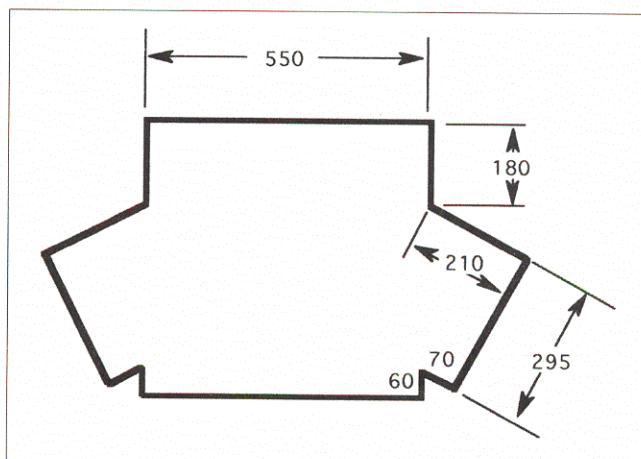

Figure 5
Dimension of base
of central part of
south tower (in
cm).

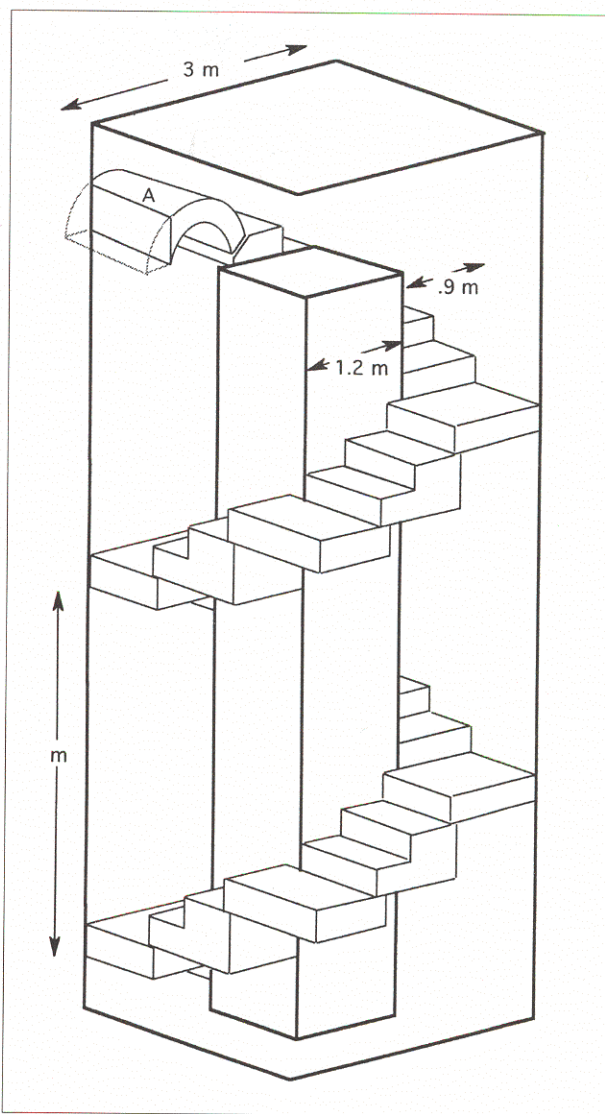

Figure 6
Interior of dressed
stone part of south tower,
up to height of 17 m.
The upper stone step was
adapted at its outer and as to
accommodate a vault ('A')
extending to the inner wall of
the tower.



Figure 7
Inside wall of
south tower
adjoining south
ramp.

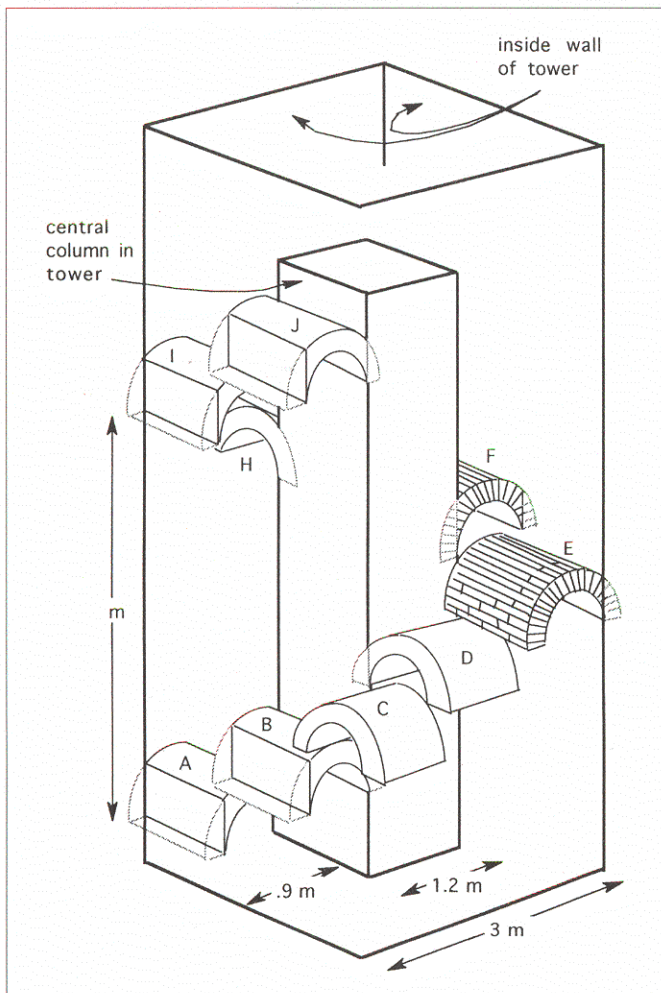

Figure 8
Reconstruction
of interior of brick
part of south tower.
Vault 'A' corresponds
with 'A' of Fig. 6.

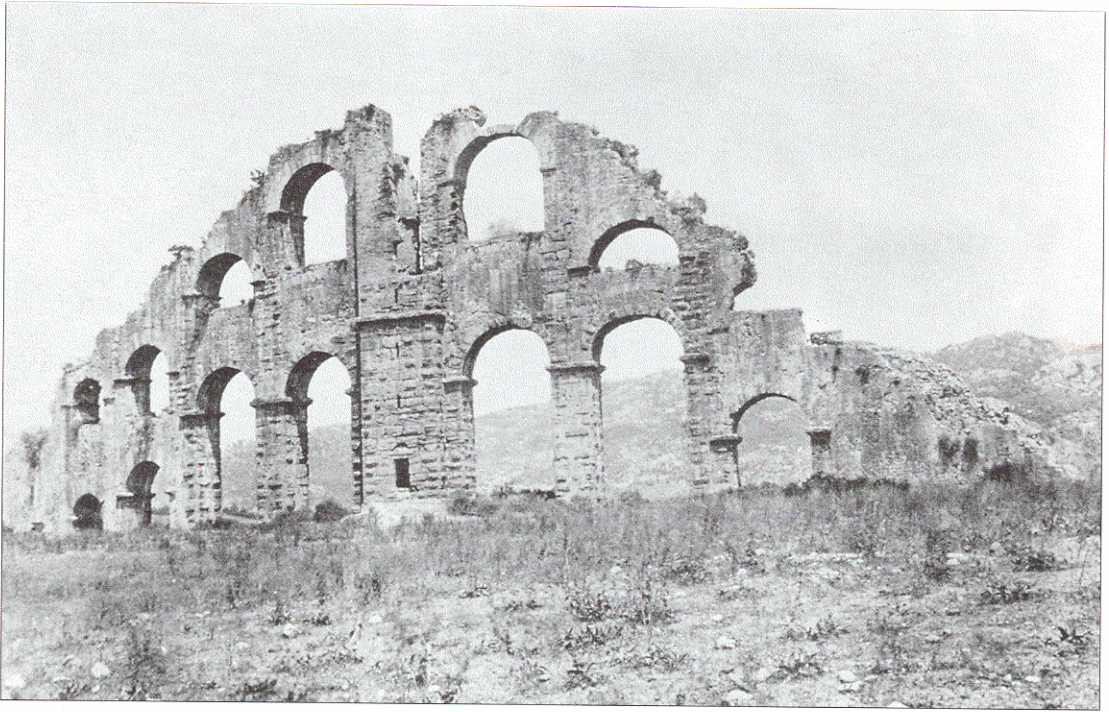

Figure 9 North tower, as seen from the west, picture taken in 1911.



Figure 10 North tower, as seen from the west, present state.

Figure 11
Piers no. 12 and 13
of the two tier bridge
connecting the south
tower to the edge of
the acropolis.

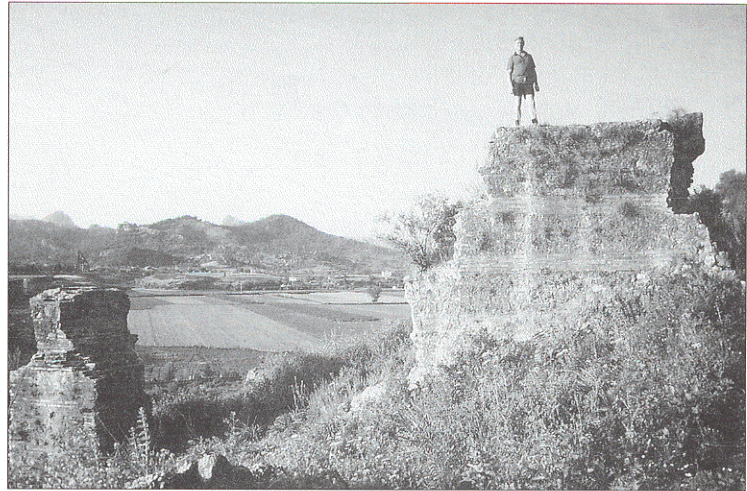

Figure 12
Remains of tower on
the edge of the
acropolis. The arch
extends in the direction
to the south hydraulic
tower.

Figure 13
Backside of
nymphaeum. Stone
elbow joints in recess
corresponding with
central niche.
Diameter of
perforations 25 cm

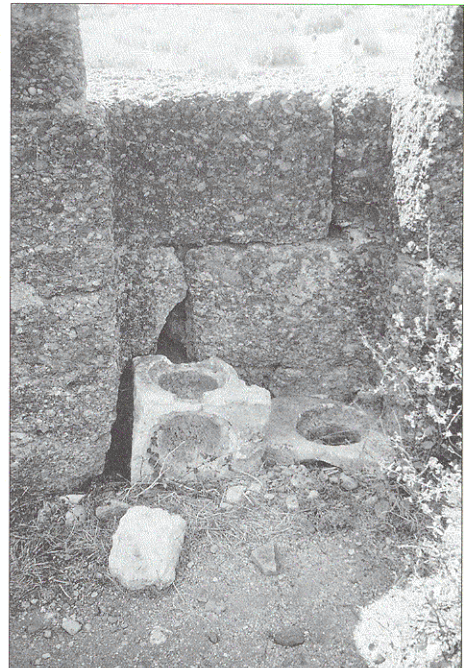



Figure 14 Backside of nymphaeum. Horizontal recess 5 m above ground level running from west side towards central niche.

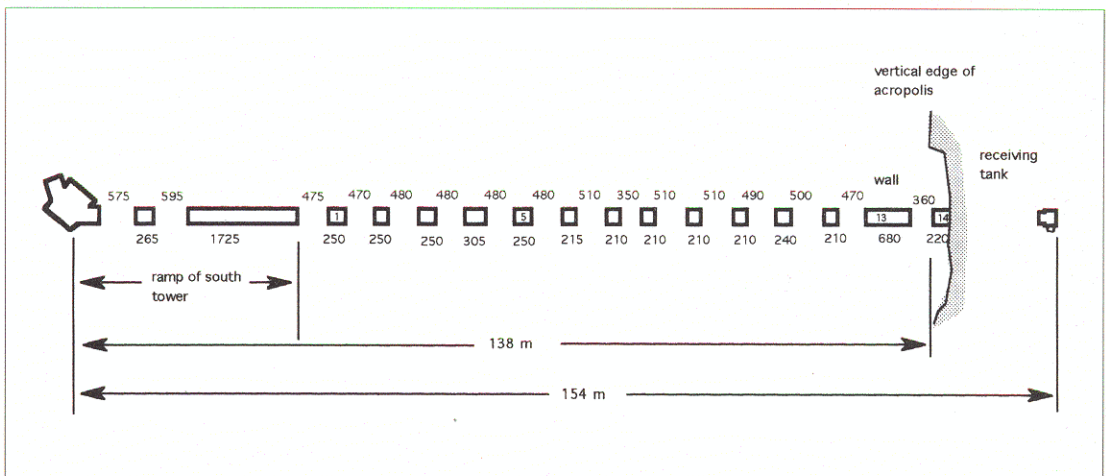

Figure 15 Plan of two tier bridge connecting south tower with the edge of acropolis (dimensions in cm); lower line: length of piers; upper line: interdistances.

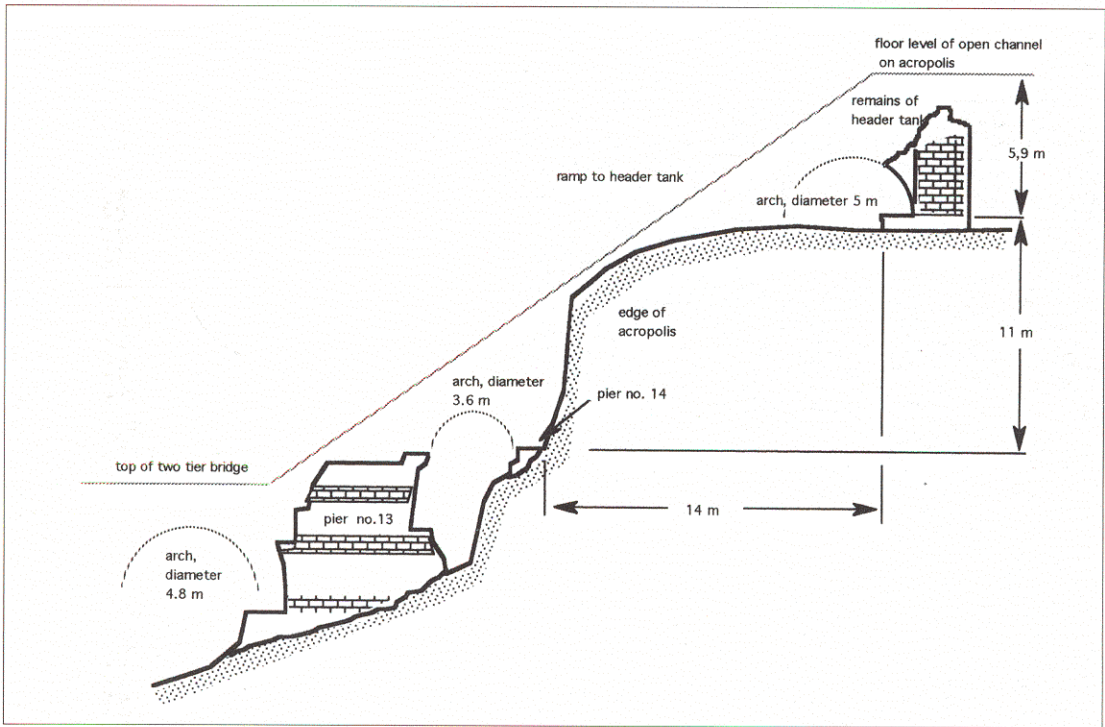

Figure 16 Reconstruction of ramp leading up to the receiving tank.



Figure 17 Mortared rubble wall, piers of low venter bridge.

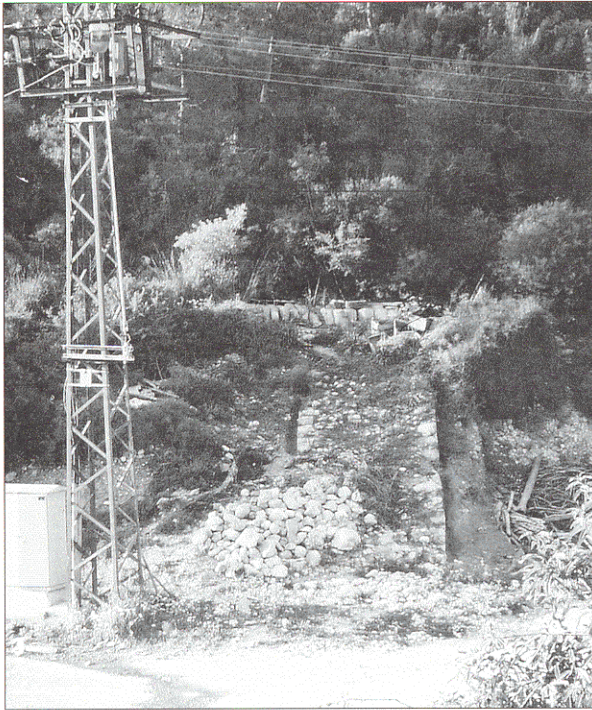

Figure 18
Foot of the first
hill of north
mountains.
Remains of wall
2.4 m wide.

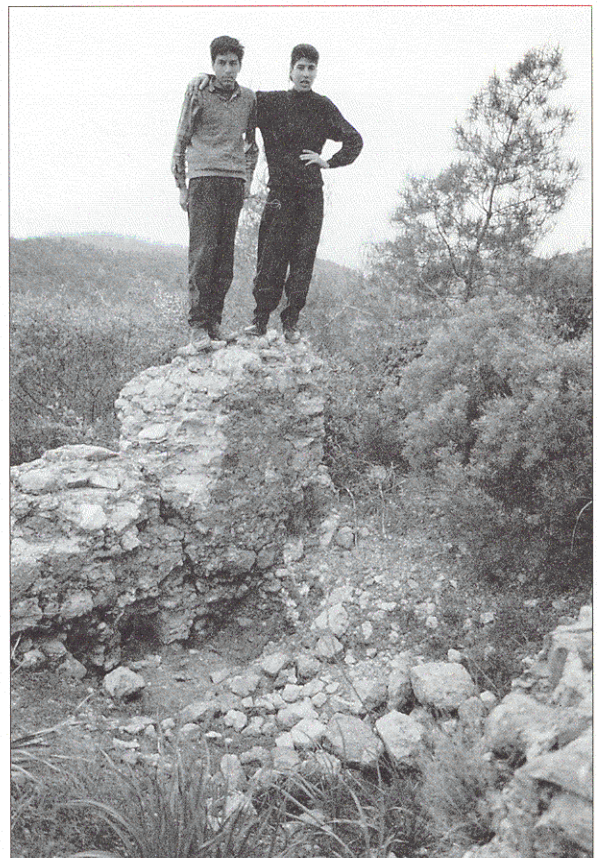

Figure 19
Rubble masonry wall 1
m wide on top of hill.
At ground level a
square orifice 30x30
cm The inside is covered
by calcareous
incrustation up to 5
cm in thickness.

Figure 20
Reconstruction of header tank.
Heavy lines indicate extant remains.

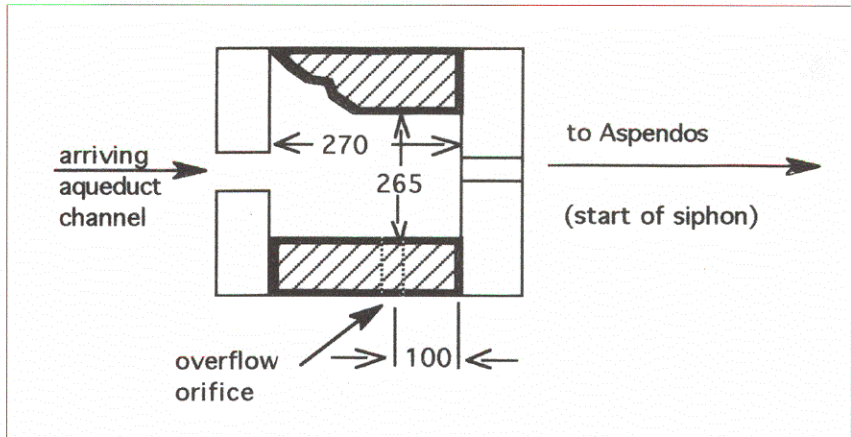

Figure 21
Aspendos siphon, theodolite data, projection on horizontal plane (dimensions in cm).

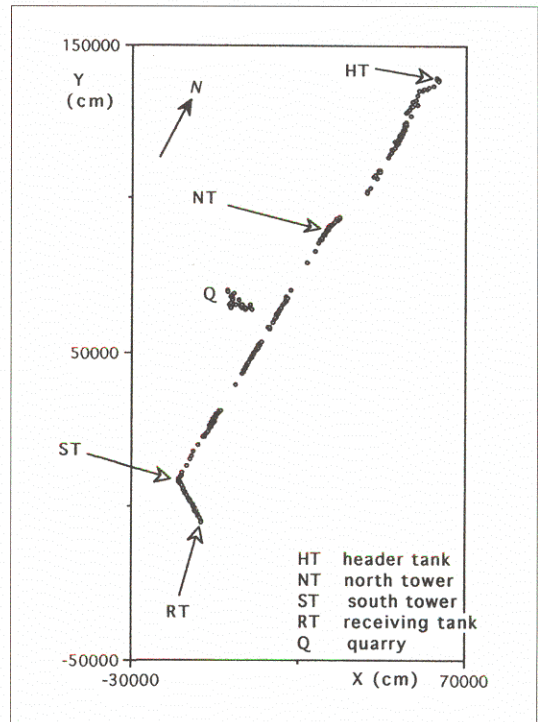
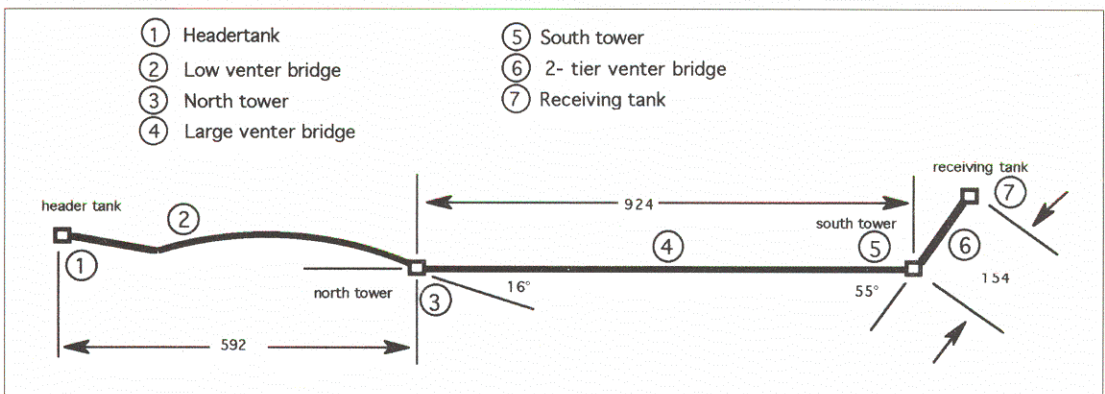

Figure 22
Schematic plan of the Aspendos siphon (distances in m).



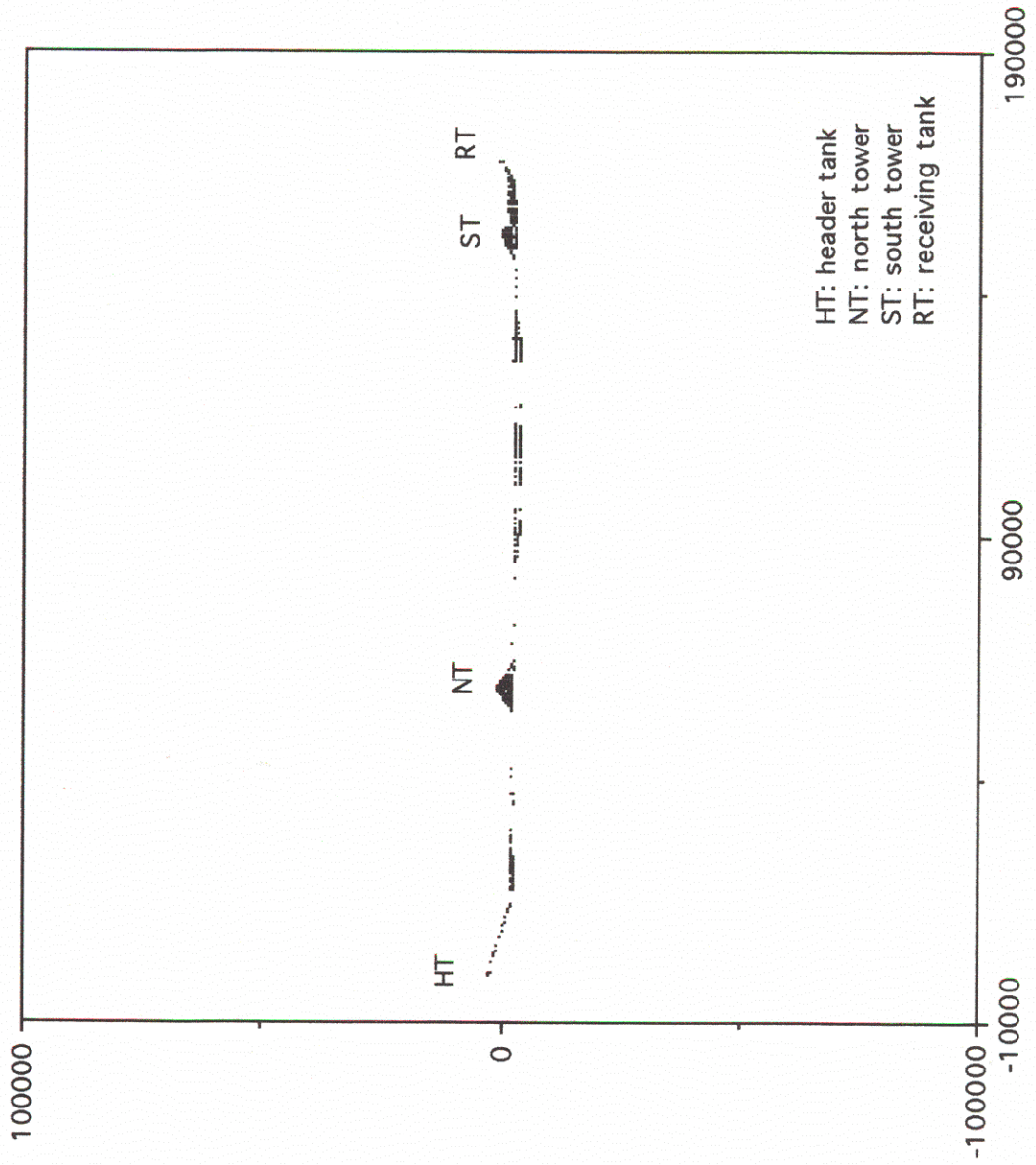

Figure 23 Aspendos siphon, theodolite data, distance along course of siphon vs height (1:1) (in cm).

Aspendos Siphon, height vs distance, height enlarged by factor of 20 Extant remains 1996

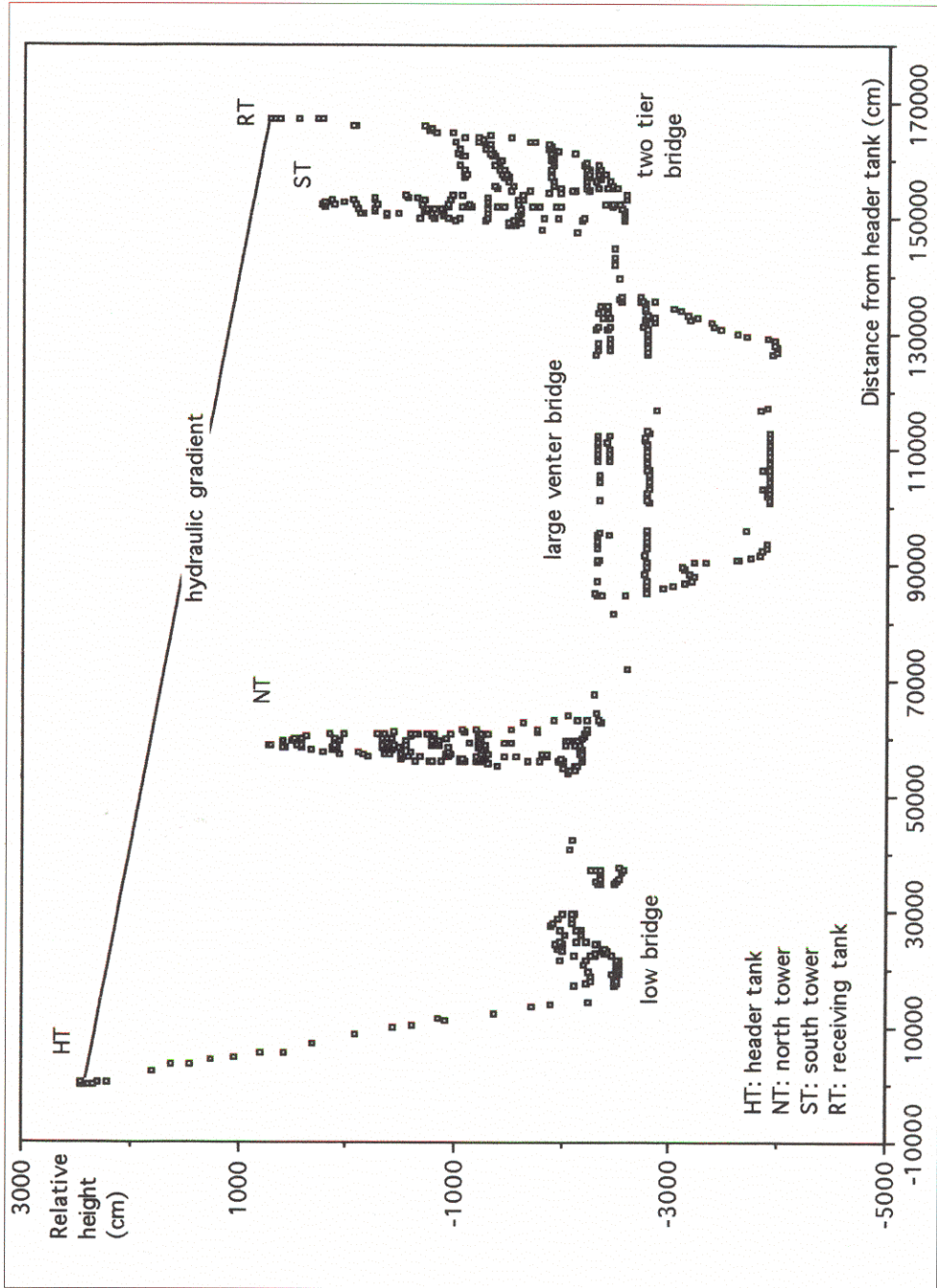

Figure 24 Aspendos siphon, theodolite data, distance along course of siphon vs height (20:1) (in cm).

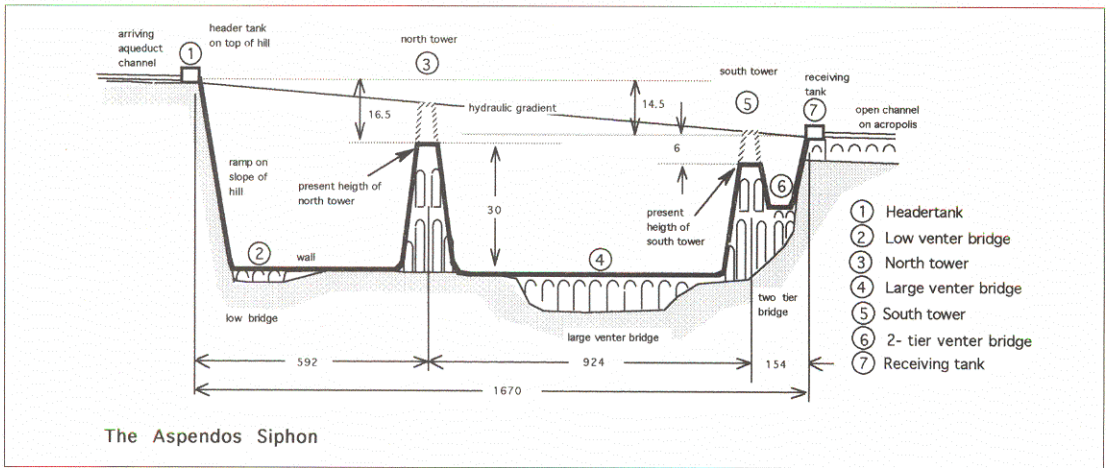

Figure 25 Aspendos Siphon, schematic profile.



Figure 26 Selçuk bridge over the Eurymedon river, 2 km south of Aspendos, incorporating stone pipe elements of the siphon.



Figure 27 Stone pipe elements, near header tank. "Vent hole" at the joint.



Figure 28 Ankara, Roma Hamam Museum.
Pipe element 90 x 90 x 50 cm with "vent hole", stone closing plug *in situ*.